

DESCRIPTION

MT79335 is a single-stage, primary side control AC-DC LED driver with active power factor correction. MT79335 integrates on-chip PFC circuit operates in critical conduction mode (CRM) to achieve high power factor and reduce the power MOSFET switching loss. With MAXIC Proprietary control technique, precision LED current is achieved without secondary side sense and feedback circuit including opto-coupler.

Embedded with 600V power MOSFET, the peripheral circuit is simplified.

MT79335 provides various protections, such as over current protection (OCP), over voltage protection (OVP), short circuit protection (SCP) and over temperature protection (OTP), etc, to improve system reliability.

FEATURES

- Single-stage Active PFC for high power factor and low THD
- Primary side control eliminates opto-coupler
- High precision LED current (+/-3%)
- Critical Conduction Mode operation
- Cycle-by-cycle current limiting
- Under-voltage lockout (UVLO) protection
- VDD and output over voltage protection
- Adjustable constant current and output power setting
- Power on soft-start
- Embedded with 600V power MOSFET
- DIP8 package

APPLICATIONS

- AC/DC LED driver applications
- Signal and decorative LED lighting
- E27/PAR30/PAR38/GU10 etc. LED lamp
- T8/T10 LED String

Typical Application Circuit

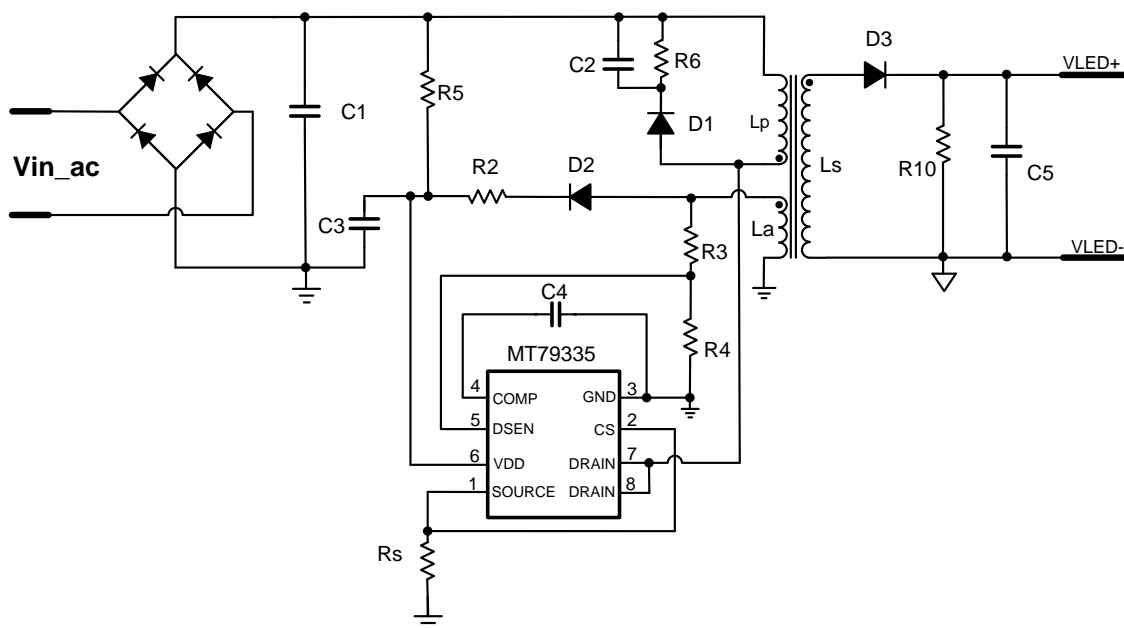

ABSOLUTE MAXIMUM RATINGS

VDD Voltage	-0.3V to VDD Clamp
DRAIN Pin Voltage	-0.3V to 600V
COMP/CS/SOURCE/DSEN Pins Voltage	-0.3V ~ 5V
Lead Temperature (soldering, 10 sec.)	260°C
P _{DMAX} (maximum power consumption)	1.5W
Storage Temperature	-55°C ~ 150°C
Junction Temperature (T _j)	150°C

Recommended operating conditions

Supply voltage	7.2V to 23V
Operating Temperature	-40°C to 105°C

Thermal resistance^①

Junction to ambient (R _{θJA})	170°C/W
Junction to Case (R _{θJC})	130°C/W

Note:

- ① Be measured in the natural convection at TA = 25°C on a low effective single layer thermal conductivity test board of JEDEC 51-3 thermal measurement standard. Test condition: Device mounted on 2" X 2" FR-4 substrate PCB, 2oz copper, with minimum recommended pad on top layer and thermal vias to bottom layer ground plane.

PIN CONFIGURATIONS

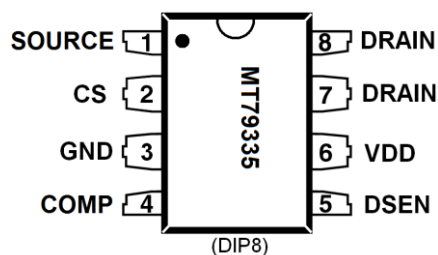

Chip Mark

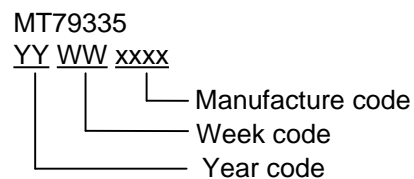

PIN DESCRIPTION

Name	Pin No.	Description
SOURCE	1	Power MOS source
CS	2	Current sense input
GND	3	Ground
COMP	4	Internal EA's output. Connect a capacitor to ground for frequency compensation.
DSEN	5	The voltage feedback from auxiliary winding. Connected to a resistor divider from auxiliary winding to sense output voltage.
VDD	6	Power Supply
DRAIN	7, 8	Power MOS drain

ELECTRICAL CHARACTERISTICS

(Test conditions: $V_{DD}=12V$, $T_A=25^{\circ}C$ unless otherwise stated.)

Symbol	Parameter	Conditions	Min	Typ	Max	Unit
Start-up (VDD Pin)						
I_{START}	Start up Current			25	50	μA
UVLO	Lower Threshold Voltage of V_{DD}	V_{DD} Pin ramp down		7.2		V
V_{START}	Start-up Voltage	V_{DD} Pin ramp up		18		V
Supply Current						
I_q	Quiescent Current	No switching		1.2		mA
Control Loop						
V_{FB}	Primary Current Sense Voltage		392	400	408	mV
V_{COMPH}	Upper Limit of COMP			2.0		V
SCP	Short Circuit Protection Threshold at DSEN pin			400		mV
OVP1	Over Voltage Protection Threshold at VDD pin			24		V
OVP2	Over Voltage Protection Threshold at DSEN			3.2		V
T_{OFF_min}	Minimum OFF time			6.4		us
Current Sense (CS Pin)						
LEB	Leading Edge Blanking of CS			240		nS
OCP	Over Current Protection at CS pin			1.8		V
Thermal Protection						
OTP	Over temperature protection			150		$^{\circ}C$
	Over temperature release hysteresis			20		$^{\circ}C$
POWER MOSFET (DRAIN/SOURCE)						
BV_{DSS}	Drain-Source Breakdown voltage		600			V
$R_{DS(on)}$	Static drain-source on-resistance	$V_{GS}=10V/I_{DS}=2.0A$			5	Ω

APPLICATION INFORMATION

MT79335 is a primary-side controller for AC-DC LED driver. The LED current can be accurately regulated through sensing the primary side information to realize real current control. MT79335 integrates power factor correction function to eliminate pollution to the AC line and works in CRM (Critical Conduction Mode). Embedded with 600V power MOSFET, the peripheral circuit is simplified and low BOM cost is achieved.

Real Current Control

MT79335 accurately regulate LED current through sensing the primary side information. The LED current can be easily set as following (refer to the application circuit in page 1):

$$I_{LED} = \frac{1}{2} \frac{N_p V_{FB}}{N_s R_s}$$

Where N_p is primary winding, N_s is secondary winding; V_{FB} (=400mV) is the internal voltage reference and R_s is an external current sensing resistor.

Start Up

During start-up process, VDD is charged through a start-up resistor. As VDD reaches 18V, COMP is pre-charged by internal circuit. After COMP reaches 0.8V, the internal control loop is well settled, which is considered as “LoopOK”. Then PWM signal drives the Internal power MOSFET to power up the convertor.

The power supply is taken over by the auxiliary winding once the voltage of this winding is high enough.

The PWM signal is shut down after VDD goes below 7.2V (UVLO threshold voltage). Meanwhile, COMP is discharged to ground. The whole start-up procedure is shown in Fig.1.

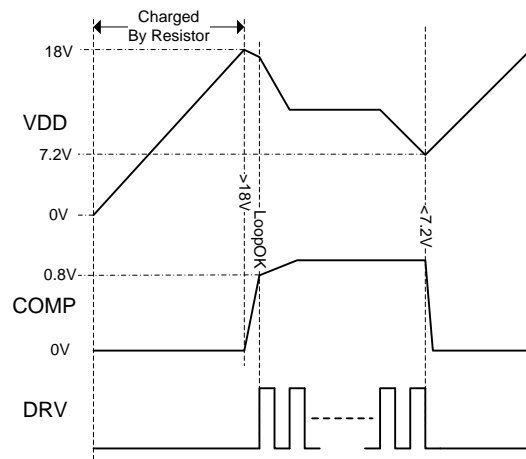

Fig.1 Start up sequence

Power Factor Correction

The primary side current increases linearly from zero to peak value, as sensed by the current sensing pin CS, during the power MOSFET on-time. When the primary current reaches the threshold, MT79335 turns off the power MOSFET immediately. MT79335 turns on the power MOSFET again after the drain of the power MOSFET damps to its valley or nearby. The peak current threshold is regulated by MAXIC proprietary technique and follows the rectified sinusoidal-shape of input voltage. As a result, the envelope of the inductor current is sinusoidal-shaped, high power factor is therefore achieved in this way.

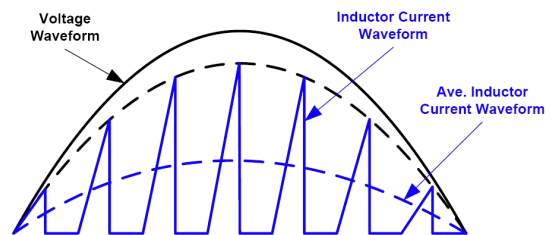

Fig.2 Power Factor Correction

Auxiliary Sensing

The turning-on of power MOSFET is controlled by sensing DSEN’s waveform, which is sampled from Auxiliary windings by the resistor-divider. As DSEN’s waveform goes below 0V at OFF time, which indicates the drain of power MOSFET damps to its valley or nearby, MT79335 turns on the power MOSFET. Besides, minimum OFF time control provide noise immunity.

Furthermore, MT79335 features over-voltage protection (OVP), short-circuit protection (SCP), and over-current protection (OCP) functions. Those protections are triggered by sensing the auxiliary winding waveform information, as the auxiliary winding voltage is proportional to the output voltage (secondary winding voltage) during the OFF time period. The auxiliary winding voltage is sampled by DSEN pin, one LEB (Leading Edge Blanking) time right after DRV signal is turned off.

Auxiliary sensing function is shown in Fig.3.

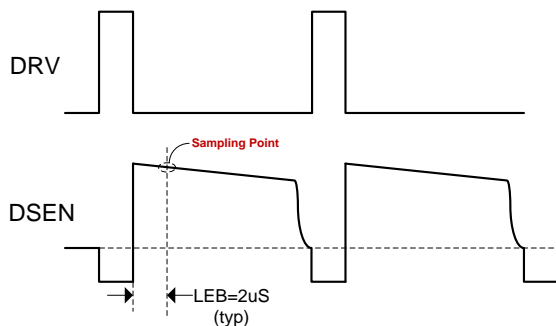

Fig.3 Auxiliary Signal Sensing

Over-voltage Protection

MT79335 is implemented with two over-voltage protection schemes: (1) If DSEN pin’s voltage is detected above 3.2V for three times, (refer to **Auxiliary Sensing** section), MT79335 turns off

the PWM switching signal, and VDD voltage gradually drops to UVLO threshold, and the system will be re-started. The threshold voltage of over-voltage protection V_{OUT_OV} , can be easily defined as (refer to the application circuit in page 1):

$$V_{OUT_OV} = 3.2 * (1 + \frac{R3}{R4}) * \frac{N_s}{N_a} + V_{D3}$$

Where N_s is the secondary winding, N_a is auxiliary winding, V_{D3} is the forward bias of the secondary side rectifier diode.

(2) If VDD pin’s voltage exceeds 24V three times, MT79335 turns off the PWM switching signal, and VDD gradually drops to UVLO threshold, and then the system will be re-started. It is highly recommended to set up the VDD voltage between 12V and 22V by designed a proper N_a to N_s ratio of the transformer.

Short-circuit Protection

The short-circuit protection is triggered if the DSEN pin voltage is detected below 400mV at OFF period for a continuous time of 5 to 10ms. The gate drive switching will be turned off, and a restart process will be kicked off when the VDD voltage drops below the UVLO threshold. This re-start process will repeat if the short-circuit condition continues to exist.

Over-current Protection

MT79335 immediately turns off the power MOSFET once the voltage at CS pin exceeds 1.8V. This cycle by cycle current limitation scheme prevents the relevant components, such as power MOSFET, transformer, etc. from damage.

PACKAGE INFORMATION

DIP8 PACKAGE INFORMATION

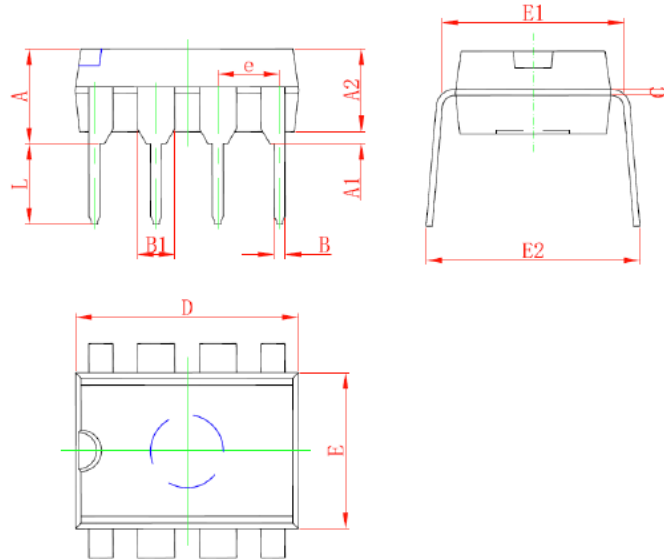

Symbol	Dimensions In Millimeters		Dimensions In Inches	
	Min	Max	Min	Max
A	3.710	4.310	0.146	0.170
A1	0.510		0.020	
A2	3.200	3.600	0.126	0.142
B	0.380	0.570	0.015	0.022
B1	1.524 (BSC)		0.060 (BSC)	
C	0.204	0.360	0.008	0.014
D	9.000	9.400	0.354	0.370
E	6.200	6.600	0.244	0.260
E1	7.320	7.920	0.288	0.312
e	2.540 (BSC)		0.100 (BSC)	
L	3.000	3.600	0.118	0.142
E2	8.400	9.000	0.331	0.354

Important Notice

- Maxic Technology Corporation (Maxic) reserve the right to make correction, modifications, enhancements, improvements and other changes to its products and services at any time and to discontinue any product or service with notice. Customers should obtain the latest relevant information before placing orders and should verify that such information is current and complete. All products are sold subject to Maxic's terms and conditions of sale supplied at the time of order acknowledgement.
- Reproduction, copying, transferring, reprinting this paper without Maxic's written permission is prohibited.
- Maxic is not responsible or liable for customer product design by using Maxic components. To minimize the risks and associated with customer products and applications, customers should provide adequate design and operating safeguards and consult Maxic's sales department.

For detail products information and sample requests, please contact:

Maxic Technology Corporation (Beijing Office)

1006, Crown Plaza Office Tower, No106, ZhiChun Road, Hai Dian District, Beijing, China, 100086

Tel: 86-10-62662828

Fax: 86-10-62662951

Maxic Technology Coporation (Shenzhen office)

Room 1115, Qinghai Building, No.7043 North Ring Road, Futian District, Shenzhen, P.C. 518000

Tel: 86-0755-83021778

Fax: 86-0755-83021336

Maxic Technology Corporation (Suzhou Office)

B-503, #3 Chuangye Park, 328 Xinghu Street, Indurial Park, Suzhou, 215021

Tel: 86-512-62958262

Fax: 86-512-62958262

Maxic Technology Corporation(Indian office)

50-B,Bhatia Colony,Ballabgarh-121004,Faridabad(INDIA)

E-mail: India@maxictech.com

Web: www.maxictech.com

E-mail: sales@maxictech.com, info@maxictech.com